

FLEXA®

80-01707-1/-2/-11

40 x 143 x 11cm

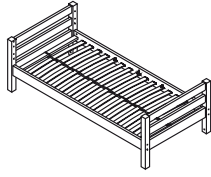
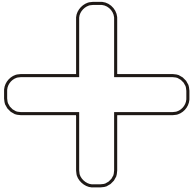

80-01101-1/-2/-11
80-01102-1/-2/-11
US: 80-01117-1/-2/-11

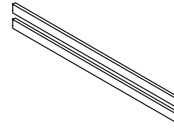

80-01601-1/-2/-11
80-01602-1/-2/-11

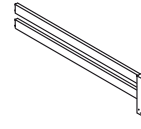

80-01605-1/-2/-11
80-01606-1/-2/-11

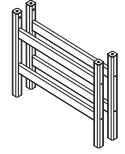

80-01501-1/-2/-11
US:80-01514-1/-2/-11

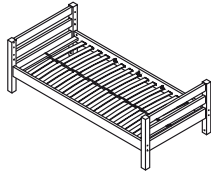

80-01101-1/-2/-11 x2
80-01102-1/-2/-11 x2
US: 80-01117-1/-2/-11 x2

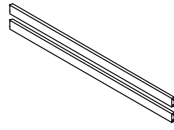

80-01601-1/-2/-11
80-01602-1/-2/-11

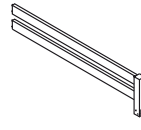

80-01605-1/-2/-11
80-01606-1/-2/-11

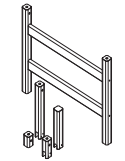

80-01502-1/-2/-11
US:80-01901-1/-2/-11

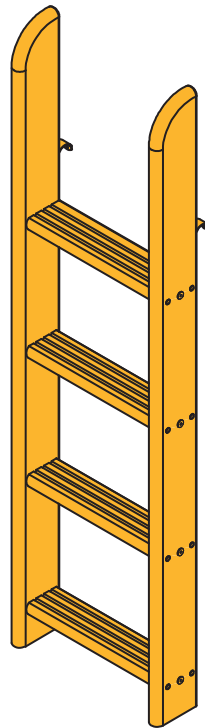

Monterings- og brugsvejledning
Assembly instructions and direction for use
Montageanleitung und Gebrauchsanweisung
Notice de montage et mode d'emploi
Montageinstructie en onderhouds voorschrift
Instrucciones de montaje y uso
Istruzioni di montaggio e uso
Kokoamis- ja käyttöohjeet
Οδηγίες συναρμολόγησης και χρήσης

Instrukcje montażu i wskazówki dotyczące użytkowania
Instruções de montagem e de utilização
Instrucțiuni de asamblare și recomandări de utilizare.
Инструкции по сборке и руководство использования
安装及使用说明
組立ておよび使用説明
รายละเอียดเกี่ยวกับวิธีกาใช้
และการติดตั้ง
설치 및 취급설명

For indoor
domestic use

Scandinavian Design made in Estonia

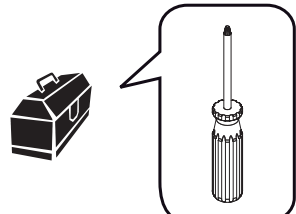
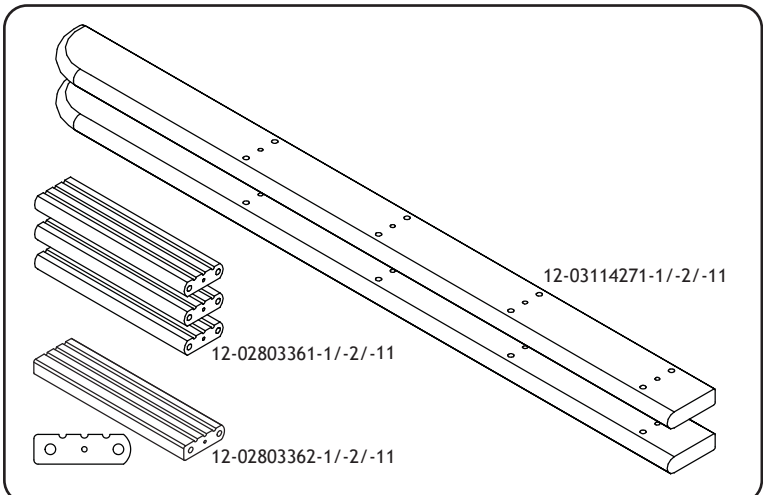
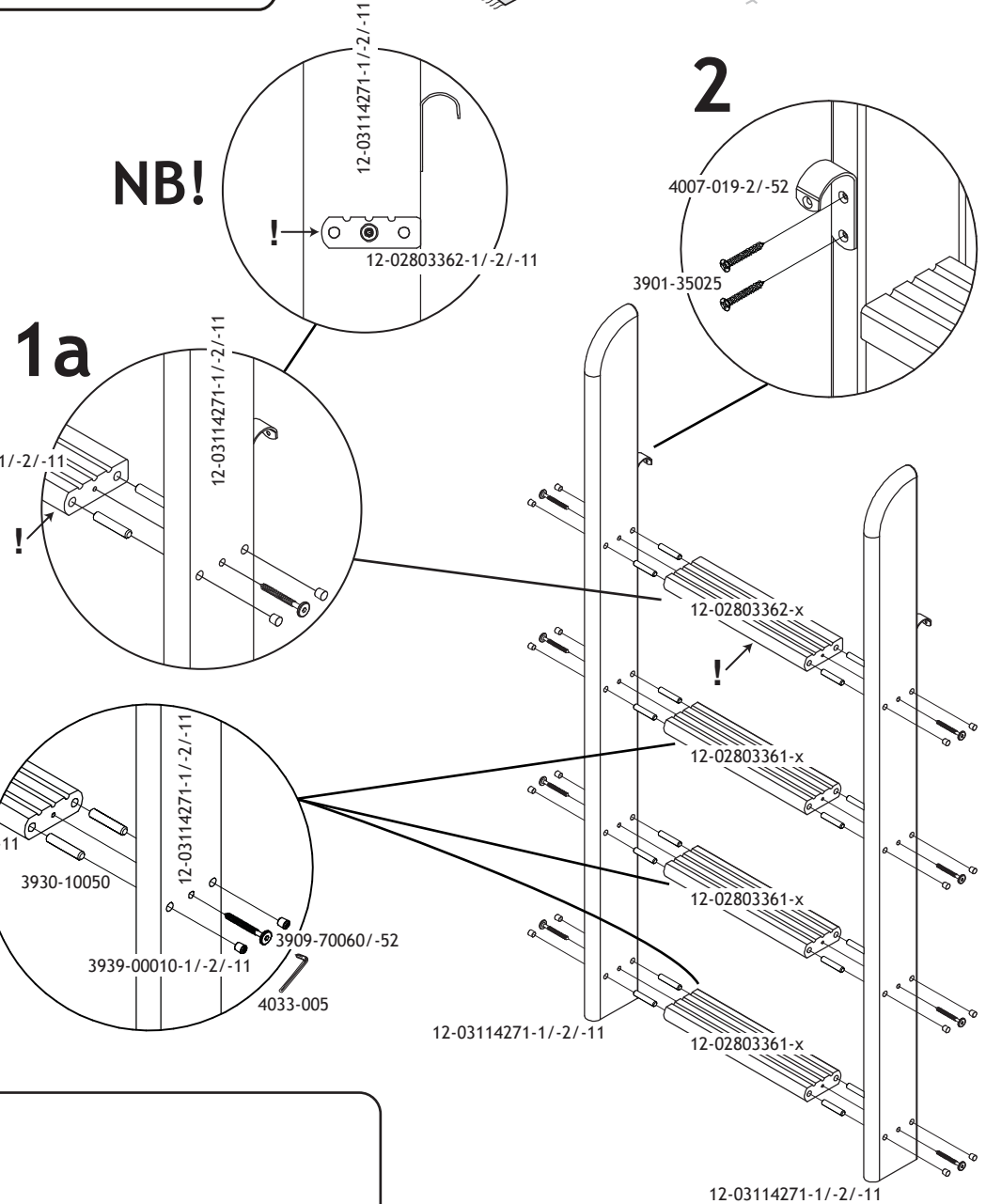
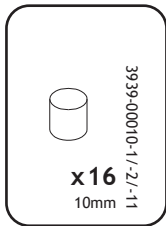
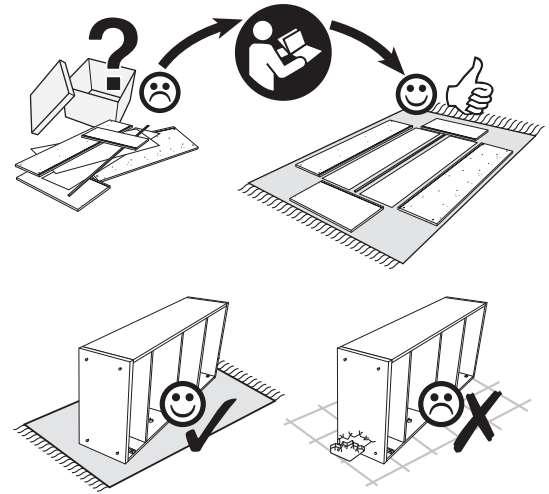
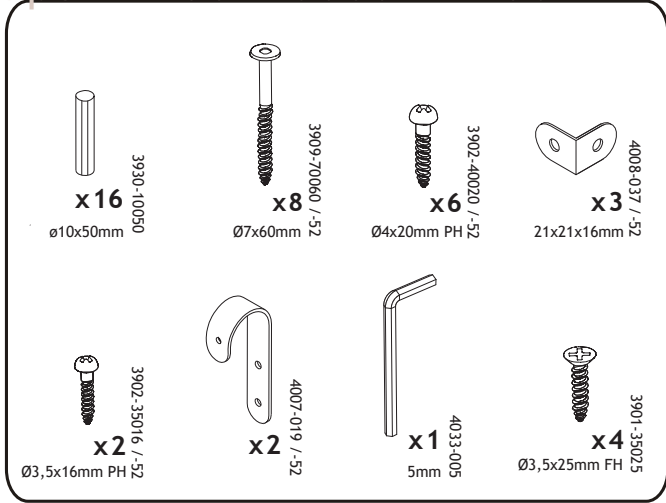

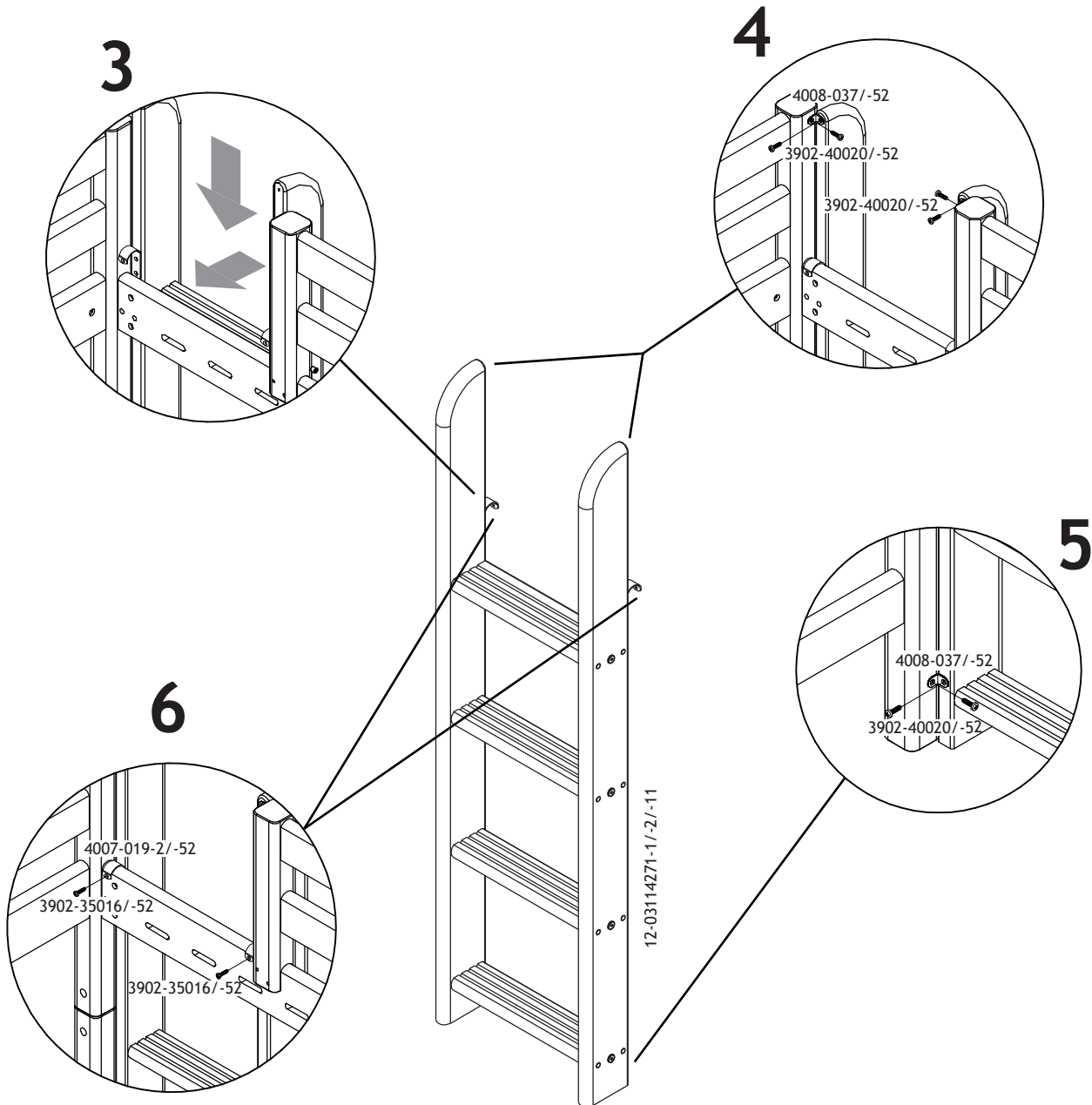

RÅD OM VELIGEHOLDELSE:

Tør af med en fugtig klud. Evt. større pletter fjernes med en fugtig svamp med sæbe. Undgå opløsningsmidler. Skruer og bolte efterspændes med jævne mellemrum.

MAINTENANCE INSTRUCTIONS:

Cleaning with a wet cloth, use a sponge with soap to remove obstinate dirt. Avoid solvents and dilutions. Screws and bolts should from time to time be retightened.

WARTUNGSANLEITUNG:

Mit einem feuchten Lappen säubern, nutzen Sie einen mit Seife getränkten Schwamm für hartnäckigere Verschmutzungen. Nutzen Sie keine Lösungsmittel oder Verdünner. Schrauben und Bolzen sollten gelegentlich neu festgezogen werden.

INSTRUCTIONS D'ENTRETIEN:

Nettoyage avec un tissu humide, utilisez une éponge avec du savon pour enlever la poussière obstinée. Évitez les solvants et les dilutions. Les vis et les boulons doivent être resserrés de temps en temps.

INSTRUCCIONES DE MANTENIMIENTO:

Limpeza con paño húmedo, use una esponja con jabón para remover la suciedad difícil de quitar. Evite solventes y diluciones. Los tornillos y pernos deben reajustarse ocasionalmente.

ONDERHOUDSINSTRUCTIES:

Schoonmaken met een vochtige doek, gebruik een spons met zeep voor het verwijderen van hardnekkig vuil. Vermijd oplossings- en verdunningsmiddelen. Schroeven en bouten regelmatig aandraaien.

LA MANUTENZIONE:

Pulire con un panno umido, usare una spugna con sapone per rimuovere lo sporco ostinato. Evitare solventi e diluizioni. Viti e bulloni devono di volta in volta essere riavvitati.

HOITO-OHJEET:

Puhdistetaan kostealla kankaalla, lian poistamiseen voidaan käyttää sientä ja saippuaa. Vältä liuotainaineita ja laimennoksia. Ruuvit ja pultit tulee kiristää säännöllisin väliajoin.

ΟΔΗΓΙΕΣ ΣΥΝΤΗΡΗΣΗΣ:

Καθαρίζετε το προϊόν με ένα υγρό πανί και χρησιμοποιήστε ένα σφουγγάρι με σαπούνι για να απομακρύνετε την επίμονη βρωμιά. Αποφύγετε τη χρήση διαλυτικών και διαλυμάτων. Οι βίδες και τα μπουλόνια θα πρέπει να ξανασφίγγονται ανά διαστήματα.

INSTRUKCJE KONSERWACJI: Czyścić przy pomocy wilgotnej ściereczki, gąbki z mydłem. Nie stosować rozpuszczalników i rozcieńczalników. Co jakiś czas należy dokręcać śruby i wkręty.

INSTRUÇÕES DE MANUTENÇÃO:

Limpe com um pano molhado. Use uma esponja com detergente para remover as manchas mais difíceis. Evite solventes e diluentes. Os parafusos e cavilhas deverão ser apertados de tempos a tempos.

INSTRUCȚIUNI DE ÎNTREȚINERE:

Se curățați cu un material textil umed, folosiți un burete cu săpun pentru a îndepărta mizeria persistentă. Evitați solvenții și diluanții. Șuruburile și bulioanele trebuie refixate periodic.

ИНСТРУКЦИИ ПО УХОДУ:

Очищать влажной тканью, для удаления стойких загрязнений использовать губку с мылом. Избегайте использования растворителей и разбавителей. Шурупы и болты следует время от времени подтягивать.

维护说明：

用湿布清洁，用海绵沾肥皂清洁顽固污垢。避免使用溶剂和稀释液。应定期重新拧紧螺丝及螺栓。

手入りの仕方:

全体を絞った布で拭き、特に汚れがひどいところは洗剤とスポンジを使って洗い落として下さい。強力な洗剤や薬品は使用しないで下さい。ねじやボルトが緩んだままになっていないように時々締め直して下さい。

유지관리 지침:

젖은 헝겊으로 세척하고, 얼룩을 제거할 때는 스폰지에 비눗물을 묻혀 사용하세요. 솔벤트나 희석제를 사용하지 마세요.

FLEXA®



Product Declaration

Product: Children's furniture

Product No: Please refer to the label or the Assembly and User Instruction. The product code refers to the type, length and color of the product. As an example the item number 80-01101-1, a basic bed, 80-01101 - 190cm long, 80-01101-1-clear lacquered. 80-01102-2, a basic bed, 80-01102- 200cm long, 80-01102-2 · white lacquered.

Technical character and size: Please refer to the Assembly and User Instruction.

Main material: Northern European Pinewood, harvested above the 60th latitude

Lacquer: Water soluble UV lacquer complying with the EN standard

Glue: Glue complying with the EN standard

Metal parts: Coating complying with the EN71 standard, part 3

Production date: Please refer to the label on the outer package.

Furniture products from FLEXA® are tested according to relevant European and American safety standards, e. g. EN, CE, GS, and CFR. Furthermore, FLEXA's products are test by the China National Quality Supervision Center for Furniture and complying with the GB28007-2011 children furniture standard in China and other relevant standards. Also, we comply with the EN717 concern the formaldehyde release.

Assembly and spare parts: Please refer to the Assembly and User Instruction.

Maintenance: Please refer to the Assembly and User Instruction.



Safety tested FLEXA furniture is made for children. We have carefully checked every single detail so you can safely set up your child's bedroom. For example, there are no sharp edges or corners on FLEXA furniture- they are all rounded. All beds with a sleeping height of more than 80 cm are safety tested according to the EU standard EN:747 by TUV.



5-year guarantee FLEXA's aim is always to deliver the highest quality and safety. That is why we provide a 5-year guarantee against manufacturing defects on all our furniture. The guarantee does not cover damage to the lacquer surface caused by knocks or wear and tear.



5-year availability guarantee on our bed system When you purchase a bed from the FLEXA Classic bed system, you buy a flexible system than can be altered and extended as and when the need arises. We offer a 5-year availability guarantee on the current FLEXA Classic bed system. If a product is no longer in our product range, the 5 year-availability guarantee still applies from the date the product is discontinued. We will notify your dealer.



Quality materials FLEXA insists on the highest quality and sustainability as a standard when we make furniture. For example, we only use the highest quality pine from sustainable forests in Scandinavian. We are thereby ensuring that only the very best material is used for our furniture.



Lacquer FLEXA furniture is surface treated with lacquer several times to give our furniture an optimal and elegant finish. At the same time it makes our furniture robust and more resistant to signs of wear and tear. FLEXA is only using eco-friendly water-based lacquer and UV lacquer, which meets the EU standard for lacquer.



Colour differences Many FLEXA furniture is made of solid wood or part of it is in solid wood and natural differences in colour may appear between individual products. This is only natural since wood is a living product. All FLEXA textiles are 100% natural products. Natural differences in colour may occur.

Children's furniture from the Danish company, FLEXA, is designed by FLEXA according to Scandinavian design traditions. The wood furniture are manufactured by FLEXA in Europe and sold worldwide.

FLEXA® and the FLEXA® logo are trademarks of Flexa4Dreams Holding A/5.

For 7 years old or above.
Only for adult to assemble.

Manufacturer: FLEXA4Dreams Holding A/5, Denmark
Address: Hornsyld Industrivej 4, 8783 Hornsyld, Denmark
Tel: +45 7668 8055 Fax: +45 7668 8069
Email: flexa@flexa.dk
Website: www.flexaworld.dk

FLEXA®



产品说明书

产 品: 儿童家具

产 品 编 号: 参见标签或包装内的安装及使用说明。产品编号代表产品的类型、长度和颜色。例如:80-01101-1, 为基本床, 80-01101-190cm, 80-01101-1-本色。80-01102-1, 为基本床。80-01102-200cm, 80-01102-2-白色。

技术特征和尺寸: 见安装及使用说明。

主 料: 北纬60度以上的北欧松木。

油 漆: 水溶性UV漆, 符合EN标准。

胶 水: 胶水符合欧洲质量标准。

金 属 配 件: 镀层符合欧洲玩具安全标准EN71, 第三部分。

芙莱莎集团出品的家具经过欧洲和美国最严格的安全测试, 符合EN, CE, GS, CFR 标准, 芙莱莎的产品经过国家家具质量监督检验中心的检测, 符合儿童家具通用技术条件GB28007-2011——目前国内唯一的儿童家具国家强制标准和其他相关国家标准。同时我们符合欧洲标准EN717中针对甲醛释放的要求。

安 装 及 配 送: 见安装及使用说明。

日 常 维 护 保 养: 见安装及使用说明。



安全保证 芙莱莎专为儿童制造, 我们专注于每一个细节, 以确保您可以安心布置儿童房, 例如, 芙莱莎儿童家具全无尖锐的边和角, 所有边角都作磨圆处理; 所有高度超过80厘米的床都要经过德国莱茵的高层床检测标准EN:747



五年质保 芙莱莎的目标是提供始终如一的高品质和安全性, 因此芙莱莎推出5年质保服务, 但仅针对家具生产制造过程中造成的缺陷, 不针对漆面的损伤。



床系统五年质保 如果您购买了芙莱莎经典系列床系统, 您就购买了一套在需要时可以变换及延展的灵活系统。我们为芙莱莎经典系列床系统提供五年质保。如果产品已经退市, 五年质保自宣布退市起始日开始计算。我们将及时通知经销商。



高品质的木材 芙莱莎始终如一地坚持最高品质, 例如, 我们只选用北欧斯堪地纳维亚森林中最优质的松木制作儿童家具。



掉 漆 芙莱莎儿童家具的表面都用水溶性UV漆涂刷好几遍, 以确保家具的最佳呈现, 同时, 可以让家具更加耐磨耐损。芙莱莎所使用的水溶性UV漆达到EU标准。



自然色差异 芙莱莎家具由纯松木制成, 由于实木具有活性, 因此会存在天然的色差, 所有芙莱莎纺织品也由100%天然材料制成, 因此也会存在色差。

芙莱莎儿童家具产自丹麦, 依照斯堪的纳维亚风格所设计。芙莱莎实木家具均由欧洲生产, 然后发往全球销售。

芙莱莎® 和FLEXA® 是Flexa4Dreams Holding A/S (芙莱莎)集团的注册商标。

适用于7岁以上年龄
只允许成人安装, 儿童勿近

生产商: FLEXA4Dreams HoLding A/S, Denmark
地 址: Hornsyld Industrivej 4, 8783 Hornsyld, Denmark
电 话: +45 7668 8055 传真: +45 7668 8069
邮 箱: flexa@flexa.dk
网 址: www.flexaworld.dk