

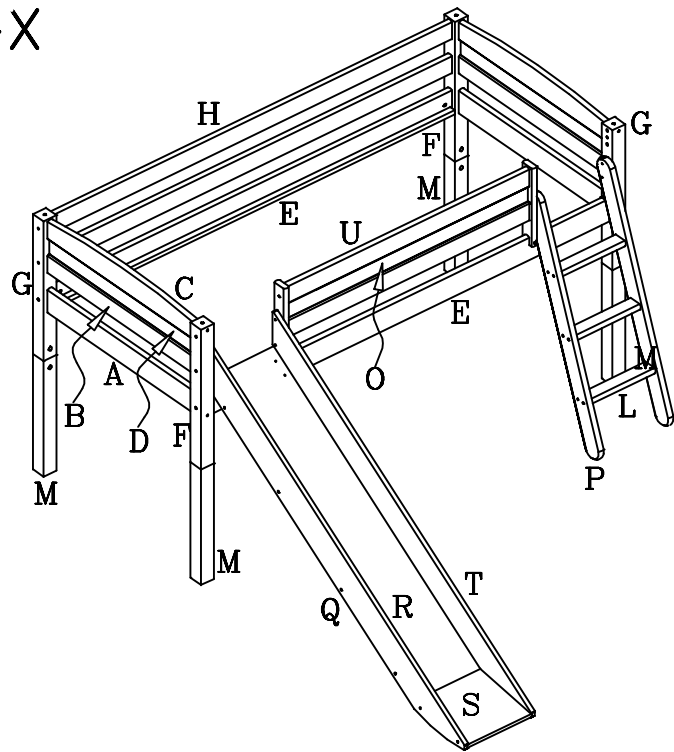

80-16308-X

White lacquer  
Weiss lack  
Blanc

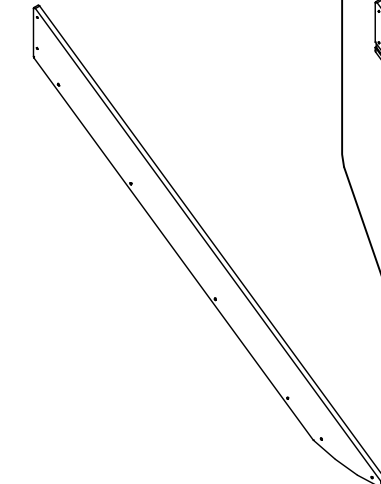
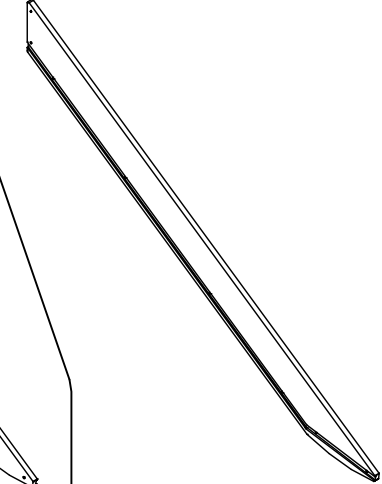
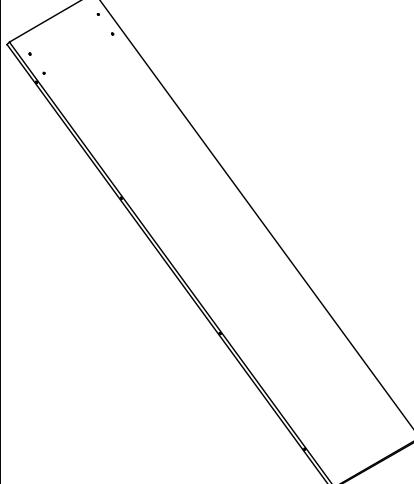
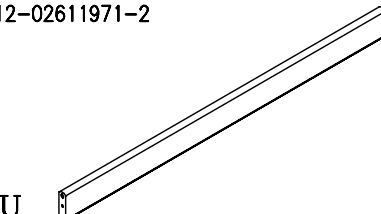
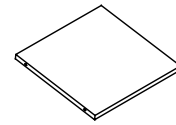

15-01918522-2 1 stck/pcs.  Q 1852x160x19	15-01918521-2 1 stck/pcs.  T 1852x160x19	4314-161475-2 1 stck/pcs.  R 1475x319x16
12-02611971-2 2 stck/pcs.  U 1197x89x26	4314-160301-2 1 stck/pcs.  S 301x319x16	

Before assembling this product, please ensure that all the components supplied comply with the list on this page. All Screw-type fittings can be tightened with this tool.

Avant de commencer l'assemblage, veuillez contrôler si tous les objets indiqués sont présents. Tous les vis peuvent être serrés par cet outil.

Bevor Sie mit dem Aufbau beginnen, kontrollieren Sie ob alle auf der Zeichnung angegebenen Teile vorhanden sind. Bitte verwenden Sie zur Montage einen Kreuzschraubenzieher und den beiliegenden Innensechskantschlüssel.

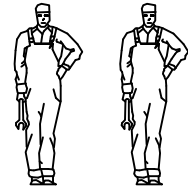
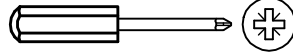



Ware-nr.  
Part no.  
Réf No

Stck.  
Qty.  
Qté.

Siehe Bild-nr.  
See picture no.  
Image no

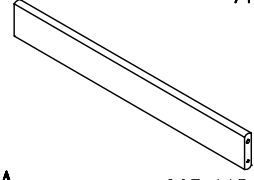
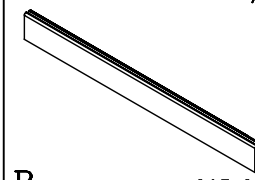
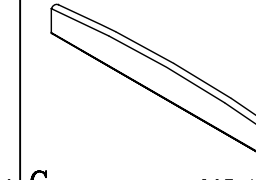
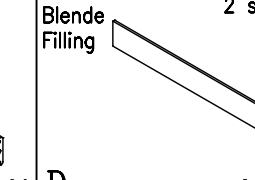
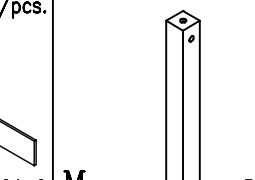
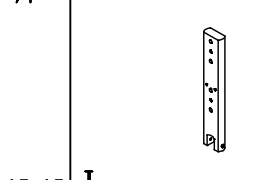
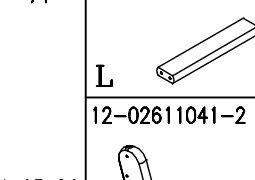
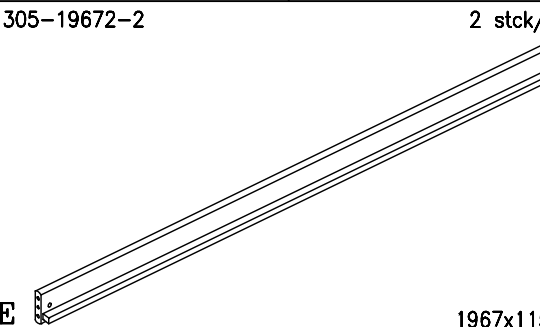
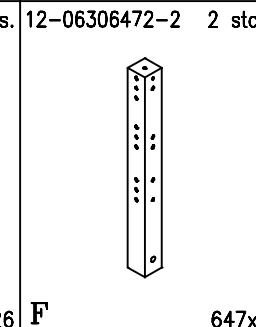
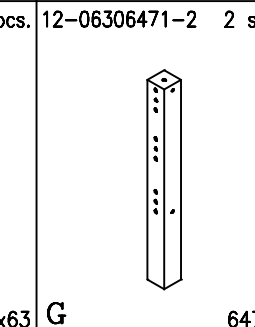
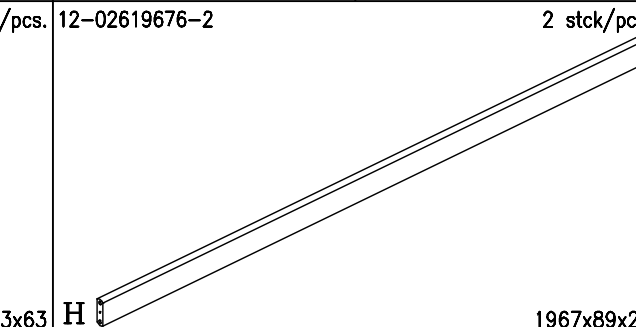
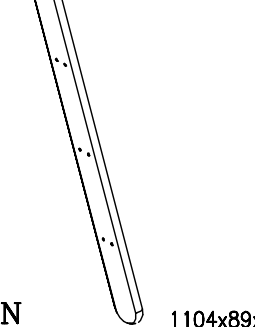
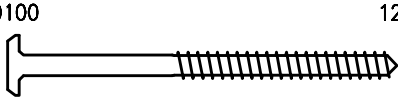
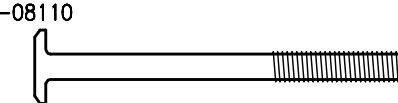
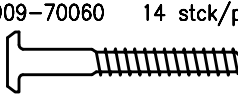
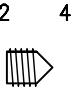
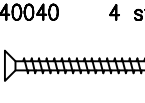
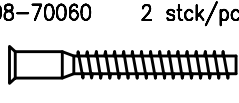
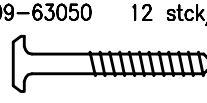
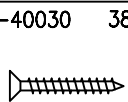
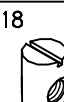
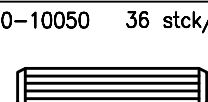
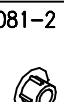
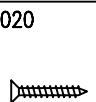
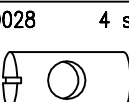
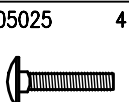
Mass  
Dim.  
Dim.

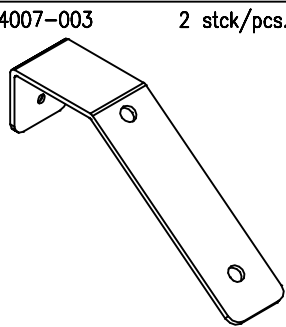
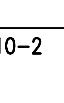
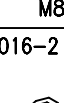
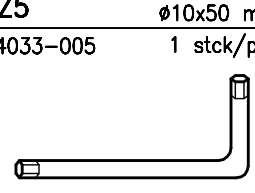
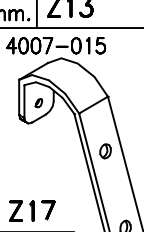
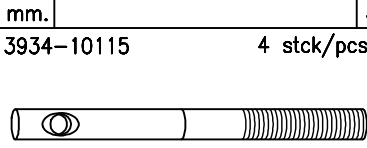
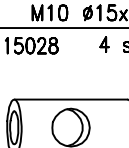
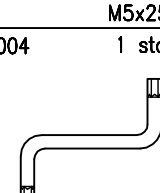
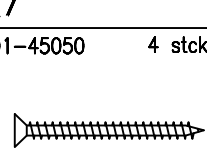
12-02608633-2 2 stck/pcs.  A 863x115x26	12-02608632-2 2 stck/pcs.  B 863x89x26	12-06808631-2 2 stck/pcs.  C 863x115x26	Panneau décoratif Blende Filling 2 stck/pcs.  D 863x89x8	12-06305352-2 4 stck/pcs.  M 535x63x63	12-02603611-2 2 stck/pcs.  J 361x65x26	12-02603182-2 3 stck/pcs.  L 318x65x26		
1305-19672-2 2 stck/pcs.  E 1967x115x26	12-06306472-2 2 stck/pcs.  F 647x63x63	12-06306471-2 2 stck/pcs.  G 647x63x63	12-02619676-2 2 stck/pcs.  H 1967x89x26	12-02611041-2 2 stck/pcs.  N 1104x89x26				
3909-70100 12 stck/pcs.  Z1 ø7x100 mm.	3913-08110 4 stck/pcs.  Z2 M8x110 mm.	3909-70060 14 stck/pcs.  Z10 ø7x60 mm.	3917-10012 4 stck/pcs.  Z12 M10x12 mm.	3901-40040 4 stck/pcs.  Z24 ø4x40 mm.	3908-70060 2 stck/pcs.  Z21 ø7x60 mm.	3909-63050 12 stck/pcs.  Z25 ø6.3x50 mm.		
3901-40030 38 stck/pcs.  Z3 ø4x30 mm.	3922-08018 4 stck/pcs.  Z4 M8/ø12x18 mm.	3930-10050 36 stck/pcs.  Z5 ø10x50 mm.	3938-000081-2 6 stck/pcs.  Z6 ø8 mm.	3901-30020 4 stck/pcs.  Z13 ø3x20 mm.	3922-10028 4 stck/pcs.  Z15 M10 ø15x28 mm.	3915-05025 4 stck/pcs.  Z26 M5x25 mm.	3927-00005 4 stck/pcs.  Z27 M5.	4007-003 2 stck/pcs.  Z28
3938-00010-2 8 stck/pcs.  Z7 ø10 mm.	3938-00016-2 8 stck/pcs.  Z8 ø16 mm.	4033-005 1 stck/pcs.  Z9 5 mm.	4007-015 2 stck/pcs.  Z17 26 mm.	3934-10115 4 stck/pcs.  Z18 M10/ø10x115 mm.	3933-15028 4 stck/pcs.  Z19 ø10x28 mm.	4033-004 1 stck/pcs.  Z23 4 mm.	3901-45050 4 stck/pcs.  Z20 ø4.5x50 mm.	

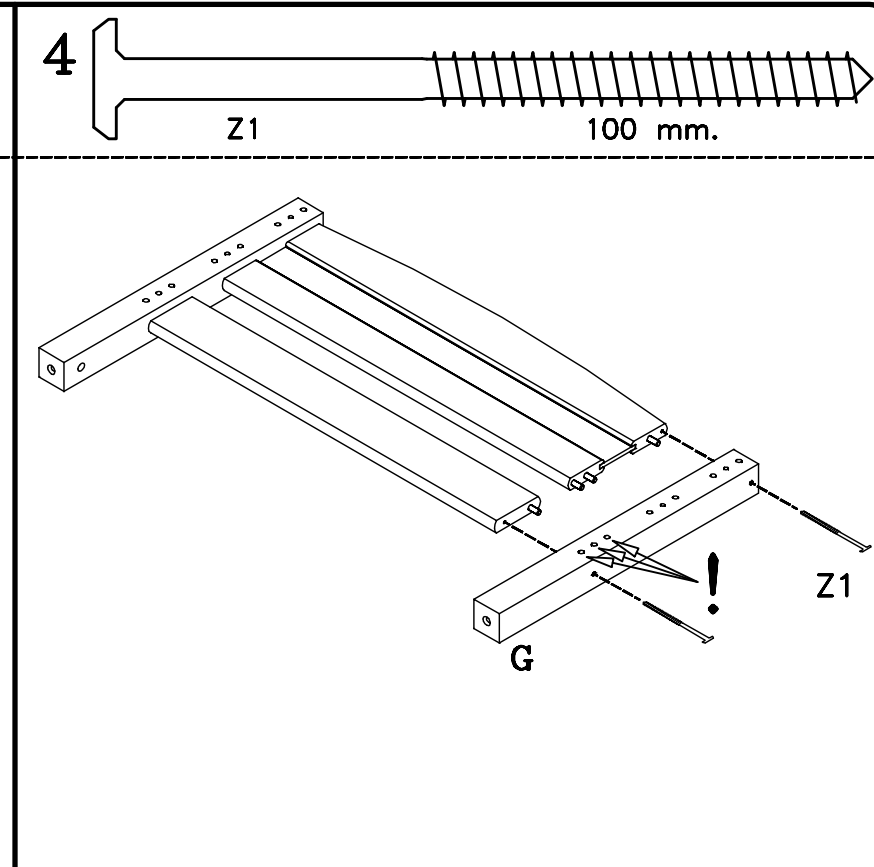
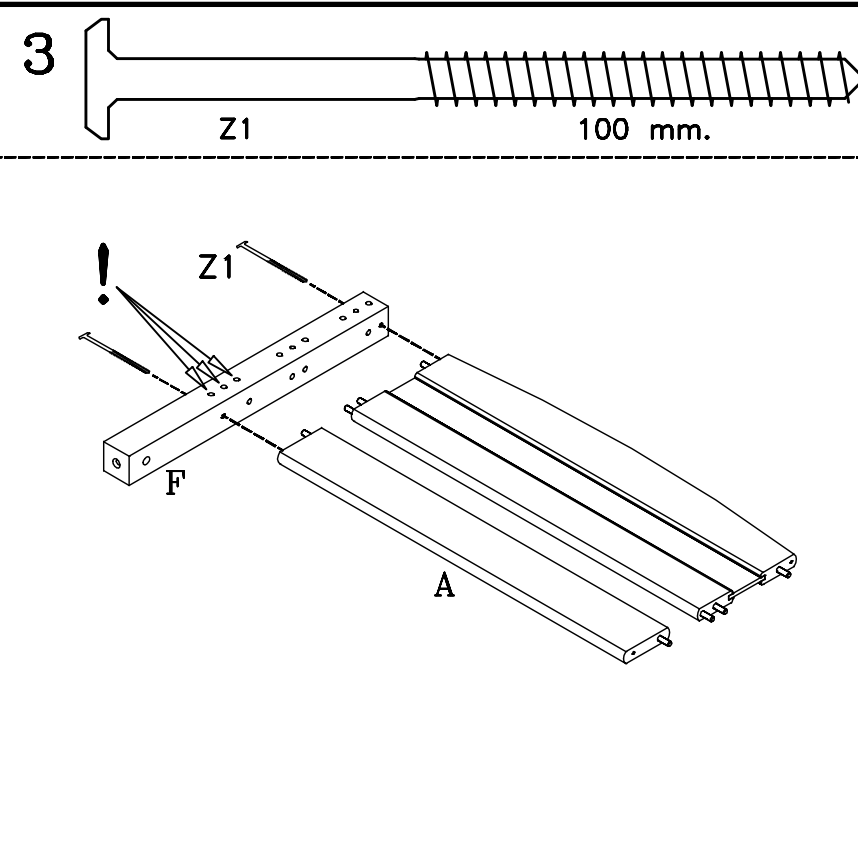
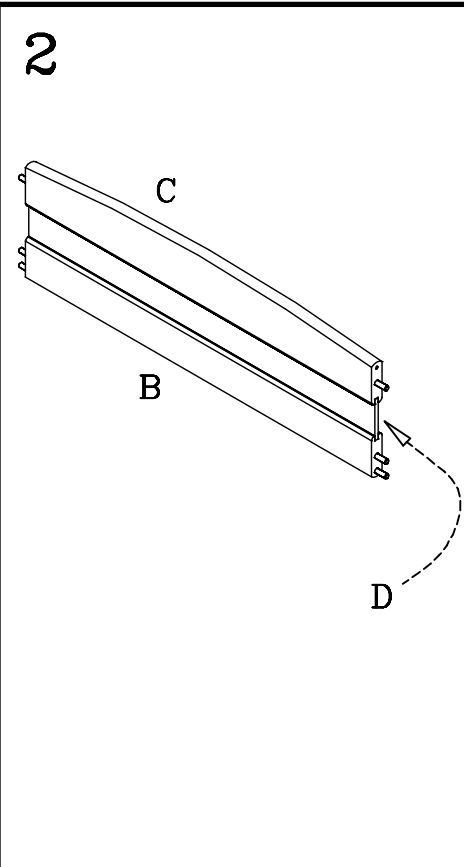
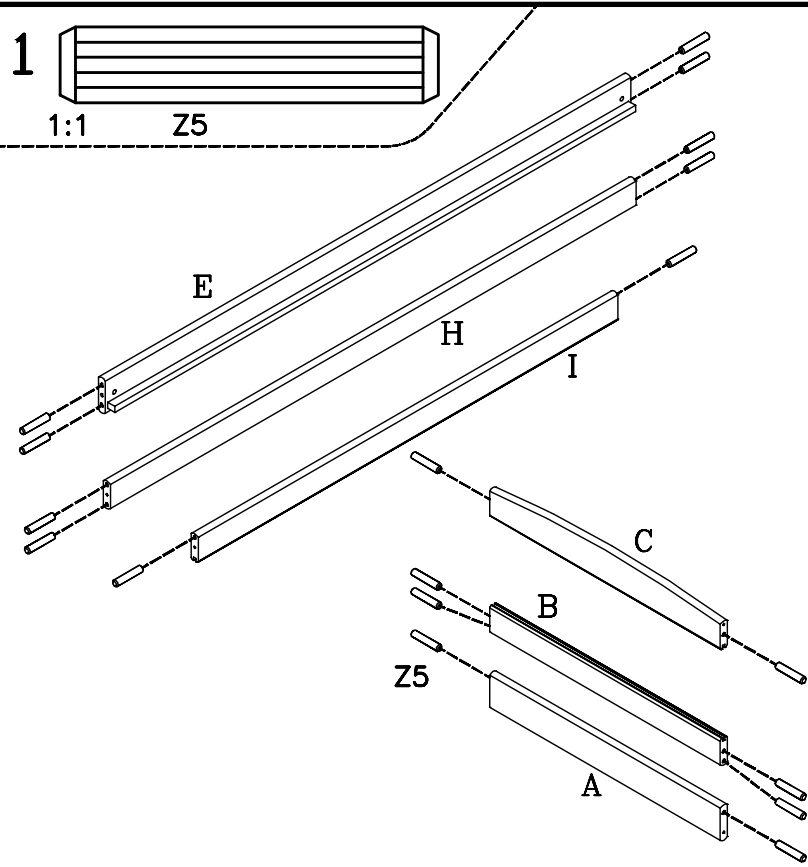

**5** Screw the bolt Z18 into the leg, until the ring on the bolt is flush with the end of the leg.

Der Verbindungsbolzen Z18 wird eingeschraubt, bis der markierte Ring mit der Oberkante des Pfostens bündig ist.

Visser le goujon dans le pied jusqu'à ce que l'anneau gravé soit à fleur avec le bois

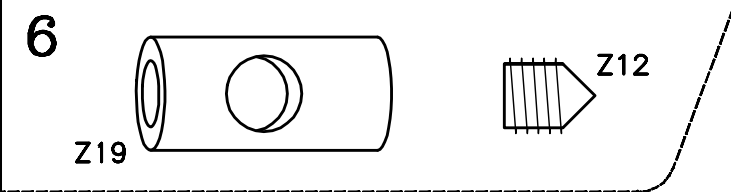

If the leg is loose after assembly, loosen the screw Z12 slightly, until the lower leg can be turned 1 time around clockwise. Then tighten the Z12 screw again.

Wenn die Pfosten nicht fest genug angezogen sind, muss die Schraube Z12 leicht gelöst werden, bis der untere Pfosten 1 Mal rechts herum gedreht werden kann. Dann muss die Schraube Z12 wieder gespannt werden.

Si les deux montants de pied ne sont pas suffisamment serrés, il convient de déserrer légèrement la vis Z12, jusqu'à pouvoir tourner la partie inférieure du pied 1 fois dans le sens des aiguilles d'une montre. Ensuite reserrer la vis Z12

